

UBIBOT

Metering Network Relay NR2

User Manual

This user manual serves as a general guidance for all types of UBIBOT® Metering Network Relay. Some features, which are marked with asterisk, are available only for specific versions. Please refer to related instructions according to the version you purchased.

PACKAGE LIST

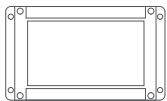

① Device



② External antenna

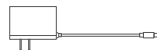

③ Adapter

Note: Please tighten the antenna before use.

INTRODUCTION

1. Basic Features Introduction

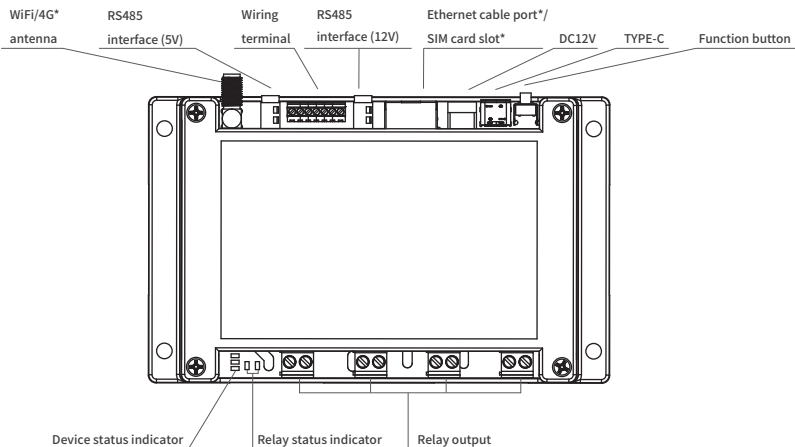

2. Device Operations

Switch On/Off

After the power is plugged in/unplugged, the device will Switch On/Off automatically.

Setup Mode

With the device switched on, press and hold the function button for about 5 seconds until the device status indicator flashes red and green alternately. Release at this time to enter the setup mode.

Send data

Under power-on state, press the function button once, the green device status indicator will flash, then connect to the network and send data.

Reset to Default Settings

Under power-on state, press and hold the function button for about 15 seconds until the red device status indicator blinks, then release the button to restore factory settings.

Electrical Wiring

1. Interface

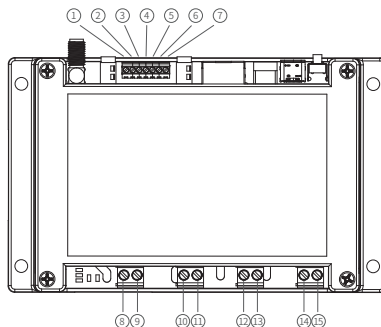

- | | |
|---------------------|-------------------|
| ① COM- | ⑧ Lout of Relay 1 |
| ② Digital Input 1 | ⑨ Lin of Relay 1 |
| ③ Digital Input 2 | ⑩ N of Relay 1 |
| ④ I/O Acquisition 1 | ⑪ N of Relay 1 |
| ⑤ I/O Acquisition 2 | ⑫ N of Relay 2 |
| ⑥ COM+ | ⑬ N of Relay 2 |
| ⑦ Output of DC 12V | ⑭ Lin of Relay 2 |
| | ⑮ Lout of Relay 2 |

2. Digital Input Wiring (2 Control Input & 2 Acquisition Input)

① Passive switch (dry contact): passive contact signal, with two states (off/on), no polarity between the two contacts, such as various types of switches, buttons, etc.

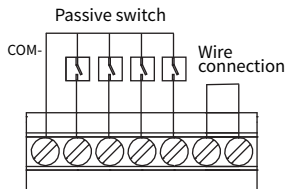

② Active switches (wet contact, DC5-12V): signals with voltage (high/low level, pulse), with two states (power/no power), polarity between the two contacts, such as liquid level detection, smoke detection, PLC output, infrared detection, flow detection, etc.

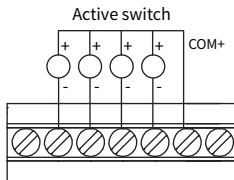

3. Relay Output Wiring

① Low load wiring: Non-resistive load current no more than 5A or resistive load no more than 16A.

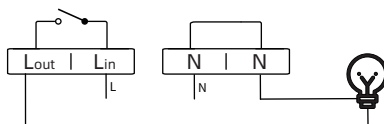

② AC 220V load wiring: external load is AC 220V power supply. The metering function cannot be used in this method.

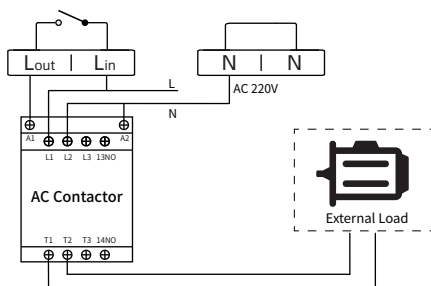

③ AC 380V (with null line) Load wiring: The external load is AC 380V with null line. The metering function cannot be used in this method.

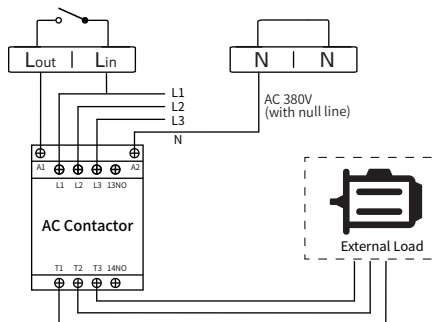

⚠ If necessary, insert an AC contactor/intermediate relay between the product and the external load.

- ① Rated load voltage > AC 250V
- ② Non-resistive load current > 5A
- ③ Resistive load current > 16A

DEVICE SETUP OPTIONS

Option 1: Using Mobile App

Download the App from www.ubibot.com/setup, or search for 'Ubibot' on the AppStore or Google Play.



We recommend you try to use the PC Tools in case the App setup fails, because the failure may be due to mobile phone incompatibility. The PC Tools is much easier to operate and suitable for both Mac and Windows.

Option 2: Using PC Tools

Download the tool from www.ubibot.com/setup.

This tool is a desktop app for device setup. It is also helpful in checking setup failure reasons, MAC address, and offline charts. You can also use it to export offline data stored in the device internal memory.

SETUP USING THE APP FOR WiFi CONNECTION

Launch the App and log in. On the home page, tap "+" to start adding your device. Then please follow the in-app instructions to complete the setup. You can also view the demonstration video at www.ubibot.com/-setup for step by step guidance.

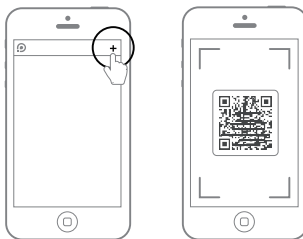

Via our app and web console (<http://console.ubibot.com>), you are able to view the readings as well as configure your device, such as create alert rules, set data syncinterval, etc. You can find and watch the demonstration videos at www.ubibot.com/setup.

SETUP USING THE APP FOR MOBILE NETWORK*

Before you set up the device on mobile data, please check the APN information of the SIM card used for the UbiBot device.

An APN (Access Point Name) provides the details your device needs to connect to mobile data through your network operator. APN details differ by network and you will need to get these from your network operator.

With the device off, insert the SIM card as indicated in the picture. Launch the app and log in. Tap the "+" to start set up the device. Please follow the in-app instructions to complete the setup process. Please note, the setup will fail if you don't have data allowance.

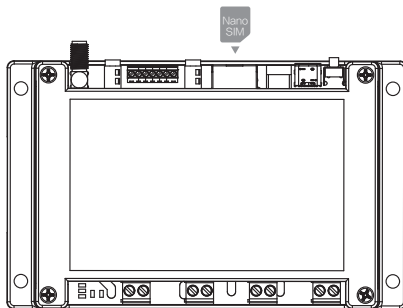

SETUP USING THE APP FOR ETHERNET CABLE CONNECTION*

STEP 1. Connect the device with power supply and plug the Ethernet cable.

STEP 2. Launch the app and log in. On the home page, tap "+" to start adding your device. Then please follow the in-app instructions to complete the setup. You can also view the demonstration video at www.ubibot.com/setup for step by step guidance.

SETUP USING PC TOOLS

- STEP 1.** Launch the App and log in. With the device switched on, use the Type-C USB cable provided to connect your device to the computer. The PC Tools will automatically scan and recognize the product ID and enter the device page.
- STEP 2.** Click "Network" on the left menu bar. There, you are able to set up the device on WiFi for all the models. For the SIM or Ethernet cable setup, please click on the corresponding button to continue.

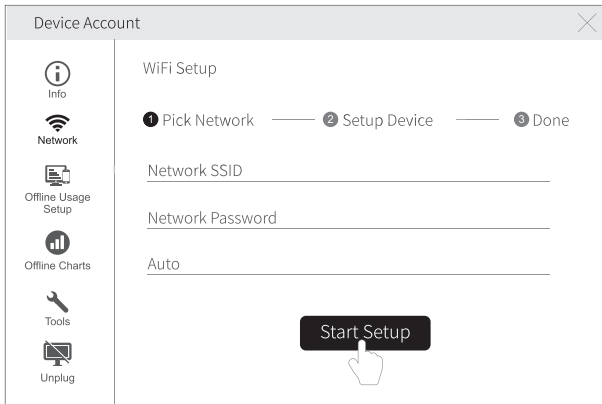



DEVICE USE

- 1. Online control mode:** you can remotely control relay operations through the UbiBot cloud platform, including opening/closing the relay, the overall synchronization or independent single-point control, timing and cycle setup, delaying tasks or defining trigger conditions through early warning rules and automation control.
- 2. Pules on/off mode:** Pulse ON, i.e., when the relay is in closed state, the relay can be set to disconnect for a period of time (set parameter*0.1s) and then close automatically. Pulse OFF, i.e., when the relay is in disconnected state, the relay can be set to close for a period of time (set parameter*0.1s) and then disconnect automatically.
- 3. Local linkage mode:** The device has 2 optocoupler inputs, which can be directly linked with the relay. It means that when the optocoupler input signal is effective, the corresponding relay will absorb/disconnect/no action; when the optocoupler input signal is canceled, the corresponding relay will disconnect/absorb/no action. The corresponding relationship between the optocoupler input and the relay's absorption/disconnection/non-activation can be set through the PC tools or the UbiBot platform.
- 4. Safety interlock mode:** The device supports safety interlock setting. Either relay is turned on, the other relay will be turned off.

DEVICE SPECIFICATION

-  Power contact capacity 250V AC/16A

-  Each relay can switch 100,000 times

-  2 x DI control inputs, 2 x DI acquisition inputs (optocoupler isolated)

-  WiFi band 2.4GHz, channel 1-13

-  1 x Type-C, 1x terminal block, 2 x relay outputs, 1 x power connector, 2 x RS485 interface

-  12V DC/2A

-  145mm x 90mm x 40mm

-  Some versions of the device support mobile network communication, network parameters are subject to the purchase of specific products and features.

-  Some versions of the device support Ethernet network communication, subject to the purchase of specific products and features.

-  12mm x 9mm x 0.8mm (standard nano card) size SIM card (optional)

-  Device operating environment: temperature range -20 to 60 °C; humidity range 5 to 85%.

FAQ

1. Device network configuration failure reasons

- ① Please check if the WiFi account password is correct;
- ② Please check whether the router is working properly and the network connection is normal;
- ③ Please make sure the device has entered the WiFi configuration mode;
- ④ Please check whether the WiFi band is 2.4GHz and the channel is between 1~13;
- ⑤ Please check the WiFi channel width is set to 20MHz or auto mode;
- ⑥ WiFi security type: NR1 supports OPEN, WEP and WPA/WPA2-personal;
- ⑦ Poor signal strength, please check the WiFi or cell phone data traffic signal strength.

2. Ethernet network* configuration failure reasons

- ① Please check whether the network cable is properly connected to the equipment;
- ② whether the network cable is intact;
- ③ whether the connected network can access the Internet;

If the above points are not abnormal, and you still cannot activate the device, you need to check whether the network environment allows DHCP (automatic IP allocation) devices to access the network; or re-scan the device QR code, select Ethernet access (advanced mode), and follow the APP prompts to manually assign IP to the device.

3. Reasons for failure to send device data

- ① Check whether the router is working properly;
- ② If using the mobile data traffic provided by the SIM card* inside the device, you need to check whether the SIM card* is activated; if the SIM card* is activated, check whether the power supply of the device is normal; also check whether the amount of the mobile data traffic provided by the device SIM card* is sufficient for the data transfer.

4. Can the device be used in a network-free environment?

The device can still work without network, and can be controlled in real time through the switch input or RS485 interface.

For more frequently asked questions, please visit www.ubibot.com and go to the "Community and Documentation" page.

TECHNICAL SUPPORT

The UbiBot team is glad to hear your voice of our products and services.

For any questions or suggestions, please feel free to create a ticket in the UbiBot app. Our customer services representatives respond within 24 hours and often in less than an hour. You can also contact the local distributors in your country for localized service. Please go to our website to view their contacts.





WARRANTY INFORMATION

1. The warranty period for this product is one year from the date of purchase. The buyer is required to submit a valid proof of purchase. During the warranty period, free repair will be provided for any failure caused by the quality of the product under normal use. The mailing cost of the returned product is the responsibility of the sender (one way).

2. The following cases are not covered by the warranty:

- ① The product is out of warranty;
- ② product failure or damage caused by incorrect or improper operation not in accordance with the product use instructions, configuration instructions, and product maintenance instructions;
- ③ accidental or man-made damage to the product, such as exceeding the temperature and humidity range of the equipment, water-caused damage, including natural water, such as water vapor, etc., fall, abnormal physical force, deformation, cable breakage, etc.;
- ④ damage due to natural wear and tear, consumption and aging, etc. (including shells, cables, etc.);
- ⑤ failure or damage caused by unauthorized dismantling of the product without permission;
- ⑥ failure or damage caused by force majeure, such as earthquake, fire, lightning strike, tsunami, etc.;
- ⑦ other non-product design, technology, manufacturing, quality and other issues caused by the failure or damage.

PRODUCT MAINTENANCE INSTRUCTIONS

-  Please always follow the instructions contained in this manual.
-  Always mount the device on a stable surface.
-  Keep away from acidic, oxidising, flammable or explosive substances.
-  When handling the device, avoid using excessive force and never use sharp instruments to try and open it.
-  Please use common USB Cable or original charger. Otherwise, It may result to danger. When you use a charger for charging, adapter shall be installed near the equipment and shall be easily accessible.

Parameters of Power adapter: Input: AC 110~240V, 600mA, 50/60Hz. Output: DC 12V, 1000mA.

FCC Statement

This equipment has been tested and found to comply with the limits for a Class B digital device, pursuant to part 15 of the FCC Rules. These limits are designed to provide reasonable protection against harmful interference in a residential installation. This equipment generates, uses and can radiate radio frequency energy and, if not installed and used in accordance with the instructions, may cause harmful interference to radio communications. However, there is no guarantee that interference will not occur in a particular installation. If this equipment does cause harmful interference to radio or television reception, which can be determined by turning the equipment off and on, the user is encouraged to try to correct the interference by one or more of the following measures:

- Reorient or relocate the receiving antenna.
- Increase the separation between the equipment and receiver.
Connect the equipment into an outlet on a circuit different from that to which the receiver is connected.
Consult the dealer or an experienced radio/TV technician for help.

Caution: Any changes or modifications to this device not explicitly approved by manufacturer could void your authority to operate this equipment.

This device complies with part 15 of the FCC Rules. Operation is subject to the following two conditions: (1) This device may not cause harmful interference, and (2) this device must accept any interference received, including interference that may cause undesired operation.

V1.0.0